

## NIM900 Specifications

NIM900	
Optical system	Infinite optical system
Eyepiece	· SW10X/22 · SW10X/23 · EW12.5X/17.5 · WF15X/16 · WF20X/12
Viewing Head	Ergo Tilting Trinocular Head (build-in Bertrand lens), Inclined at 45°, Interpupillary Distance 47-78mm
Objective	Infinite Plan APO Objective (BF/DF)
Nosepiece	Sextuplet Nosepiece, With DIC slot
Illumination	· 12V100W adjustable Halogen lamp · Four-band Fluorescent · 100W HBO Lamp
Focusing system	Coaxial Coarse and fine adjustment, Fine division 0.2mm, Moving rang 9mm
Stage	3 layers mechanical stage ,moving range 130x85mm, flexible knob, available for different size small stage
Auxillary stage	Φ20 Field aperture, Φ28 Field aperture, Drop-shaped field aperture
Medical Output	magnification 1X, 1.5X
Image Output	Output changeable (Left side / Right side / Eyepiece tube) , Splitting ratio: Left / Eyepiece =100/0; Right / Eyepiece =80/20; Optional / Eyepiece =0/100
Observation methods	Bright field ,Dark field, DIC, Polarized , Fluorescent

## DIMENSION FIGURE

Unite: mm

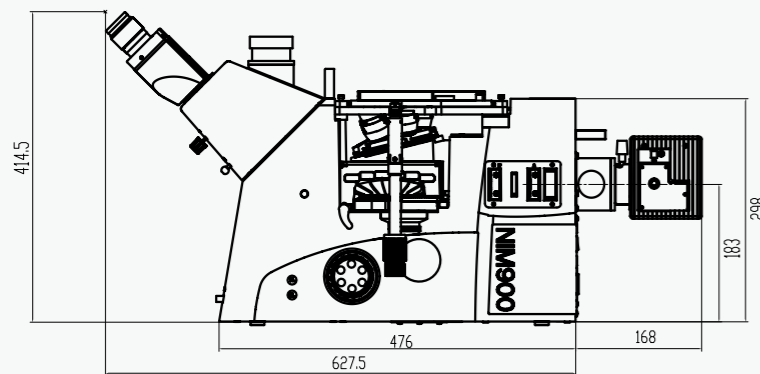

**Nexcope**<sup>®</sup>  
Scientific research microscope

NINGBO YONGXIN OPTICS CO.,LTD.

Add:No.385 Mingzhu Road,Hi-tech Industry Park,Ningbo,China.

Tel:0086-574-87915339

Fax:0086-574-87915348

E-mail: LF@yxopt.com

http://www.nexcope.com

**Nexcope**<sup>®</sup>  
Scientific research microscope

**NIM900** SERIES  
INVERTED METALLURGICAL MICROSCOPE





## Mechanical Stage

3 layers mechanical stage 340x230mm, moving range 130x85mm, Maximum 30kg. The spacious workspace for large and heavy samples. Anti-scratching, suitable for observation of all kinds of materials and shapes. At the same time, there are many kinds of plates and gaskets. It can observation and analysis of all kinds of small samples. The flexible low-position knob has the accuracy and comfort for observation, when the sample moving.

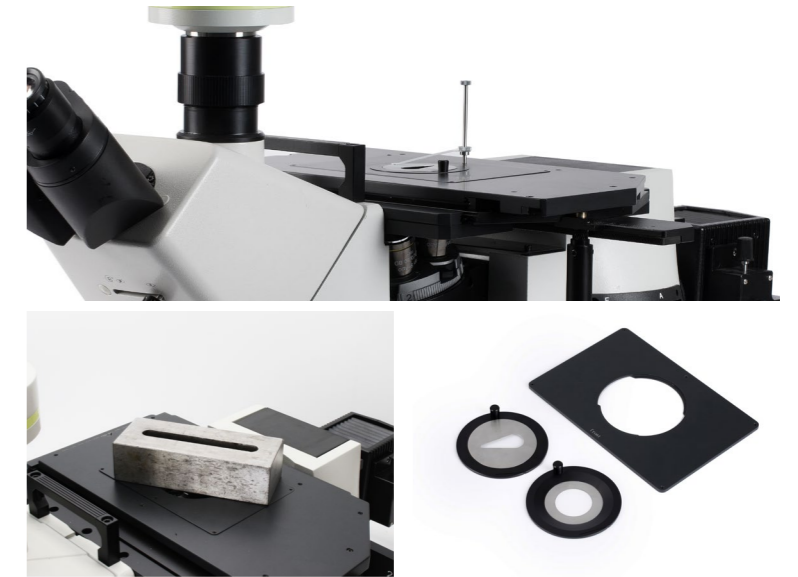

## Imaging clarity, Reliable result

### NIS45 Objective

The NIS45 objective lens can reproduce the natural color accurately by using carefully selected high-transparent glass and advanced coating techniques. For professional purposes, a variety of objectives are available, including high resolution, polarized light and long distance working objectives.



### Camera adapter at both sides

Camera adapter at both sides. Used to connect camera and various application extension accessories. By means of a spectroscopic turntable, to realization of splitting ratio of different optical paths. At the same time, it can be equipped with 0.5x, 0.7x, 1x c-mount and difference standard cameras to meet different image requirements.

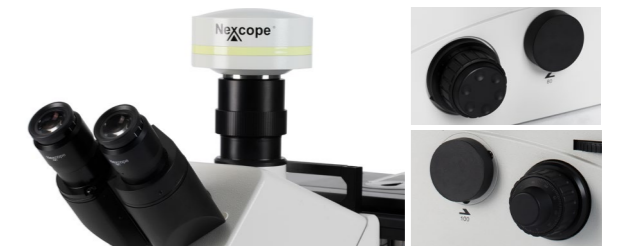

### Medial changeable lens

With built-in turret structure, 1X and 1.5X lens can be changed accordingly.



### Kohler Illumination

Kohler Illumination is regarded as the perfect micro-illumination system, which provides perfect bright and uniform field of view, and makes it possible to expand the function of microscope at the same time.

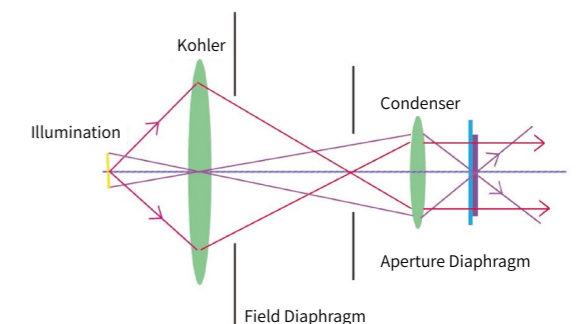

## High flexibility, offer more possibilities



### 多种调节滑块，获取清晰图像

Field adjusting diaphragm and iris diaphragm can be used to adjust the field of view and the sharpness of the imaging, also adjust aberration. The iris diaphragm and filter can easily adjust the brightness or color of light. The polarizer slider can adjust the polarizing observation and DIC image. Multiple sliders are used in combination to ensure high quality image.



### Fluorescent turret

With 6 position turret, it is easy to change different filter module.



## Ergonomic design, using comfortable



### Low-position control knobs

Coaxial focusing system with low-position X-Y coaxial control knobs. The ergonomic design provides operators comfortable experience.



### 45° Tiltable viewing head

Users can observe in any natural posture to reduce fatigue. The interpupillary distance and Diopter of the observation head is adjustable. According to user's requirement.

## Widely used and various modes of observation

With the development of scientific research, single observation model is not enough for complex scientific research and testing requirement. NIM900 achieving multiple observation requirements, regardless of Bright Field, Dark Field, DIC, Polarizing, and Fluorescent observation all can get clear, real, and complete image.

Observation methods	Bright Field	Dark Field	DIC	Fluorescent	Polarizing
NIM900	√	√	√	√	√

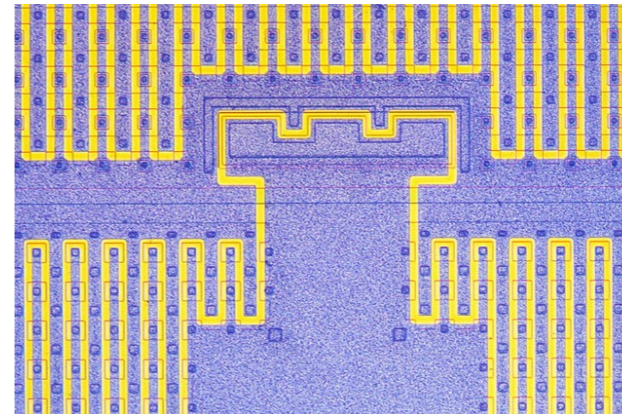

Electronic chip, Reflection, Bright field

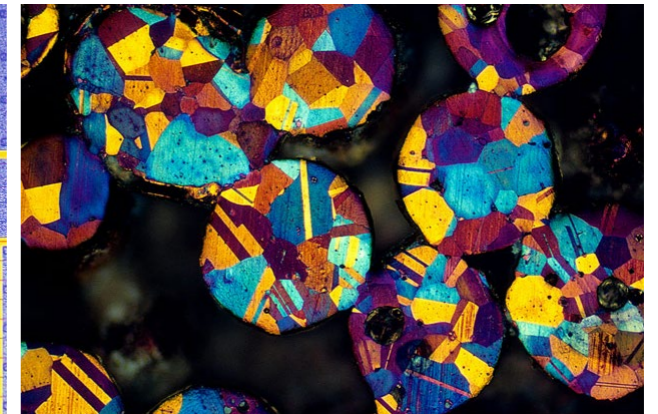

Bronze powder, Reflection, Polarizing

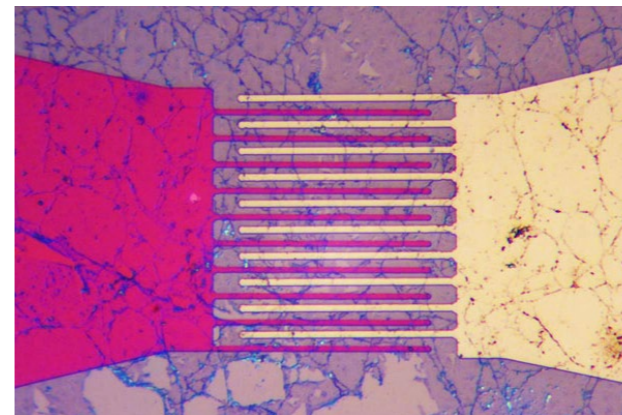

Electrode, Reflection, Bright field

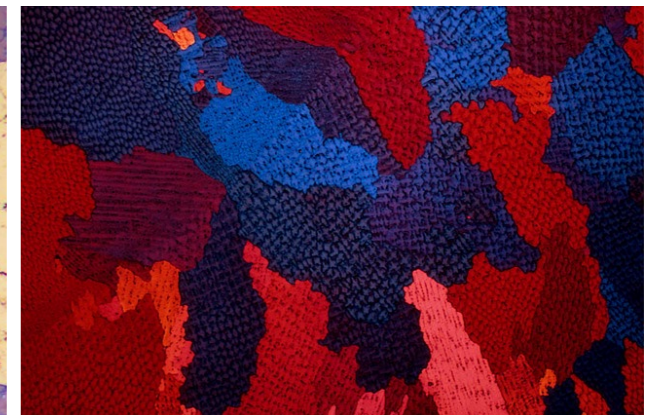

High chromium nickel alloy, Reflection, Polarizing

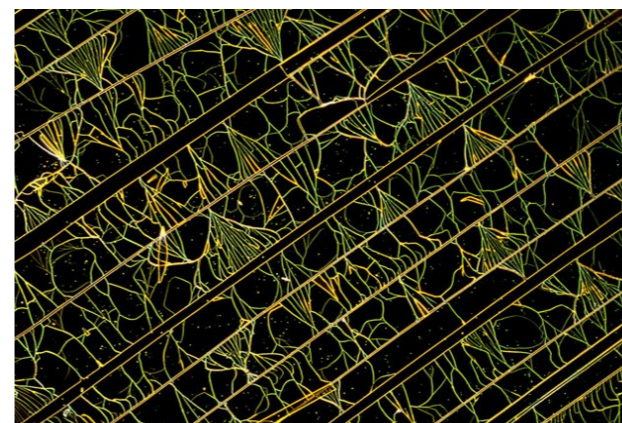

Embossing of silicon nitride, Reflection, Dark field

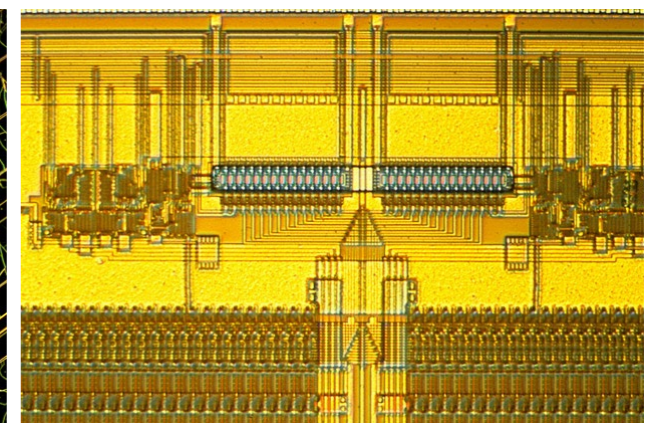

Integrated circuit, Reflection, DIC

## NOMIS Basic image processing system

Various functions of the software to meet your different image processing and analysis requirement.  
A variety of cameras can be selected to provide high-quality micro-photography scheme.  
Universal USB 3.0 interface for high speed transmission.

## Imaging software for high quality image acquisition, processing and analysis

### Image mosaicking

NOMIS Basic by collecting or importing images in real time, small images can be spliced quickly to form a large size and high resolution image.

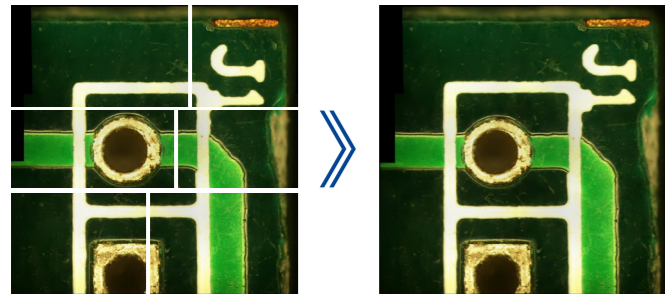

### HD real-time HDR image / video

When different samples are observed, the surface of the sample shows a high contrast area. Hdr allows users to complete the generation of perfectly exposed images between clicks.

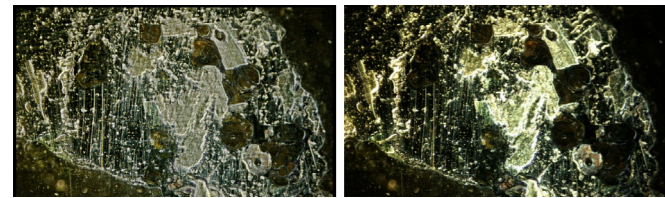

### Real time / static measurement

Typical observation and quality control require interactive measurement functions such as distance, angle, rectangle, circle, and ellipse.

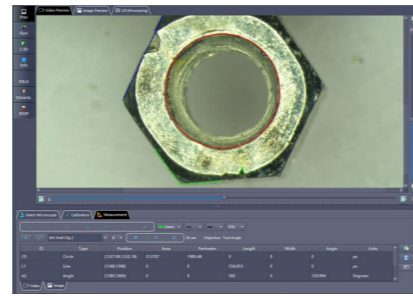

### Depth of field fusion, 3D reconstruction.

Provides depth of field fusion and 3D reconstruction by NOMIS Basic.

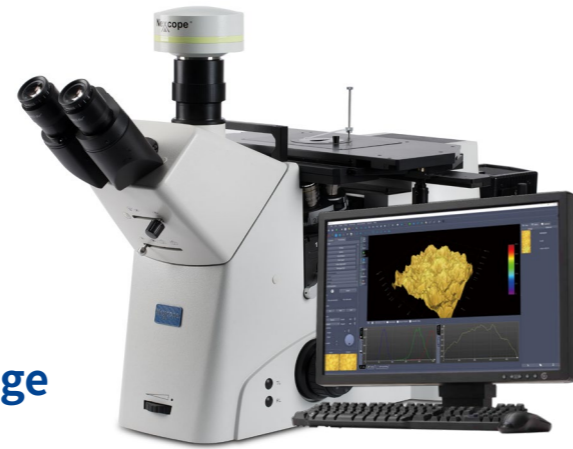
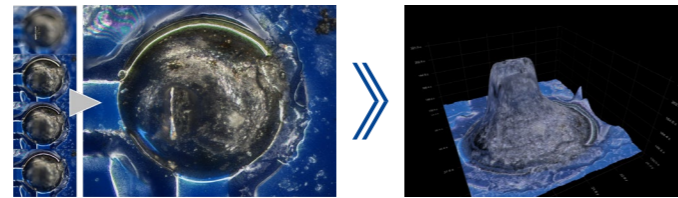

## Optional Camera



High resolution Cooling color camera  
**TC6CCD**  
1 Inch 6 MP CCD



High resolution color camera  
**T6CCD**  
1 Inch 6 MP CCD



High speed color camera  
**T16**  
4/3 Inch 16 MP CMOS

## SYSTEM LAYOUT

For Nexcope NIM900

